

JSK 450 - 10,50m x 1,50m

Janson Balkenbrücke Typ JSK 450

10,50m 13,50m 15,70m 21,00m

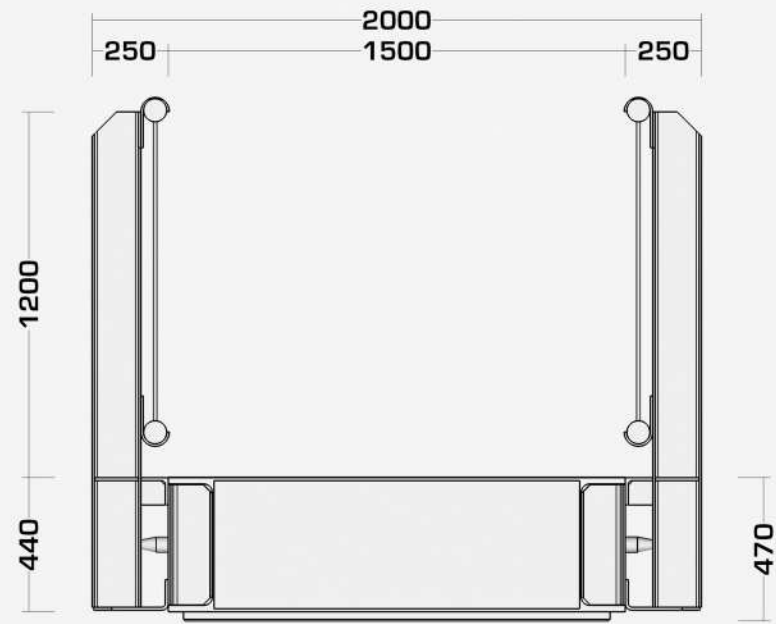

Vorderansicht

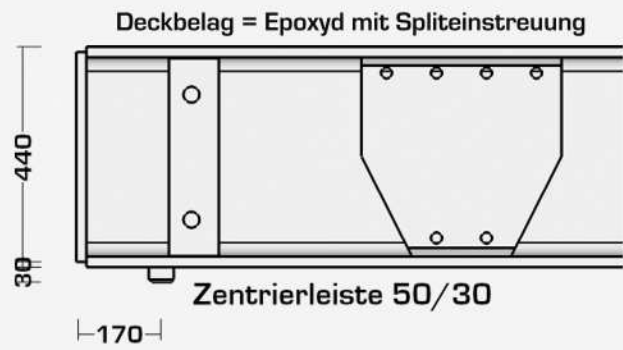

Detail: Auflager

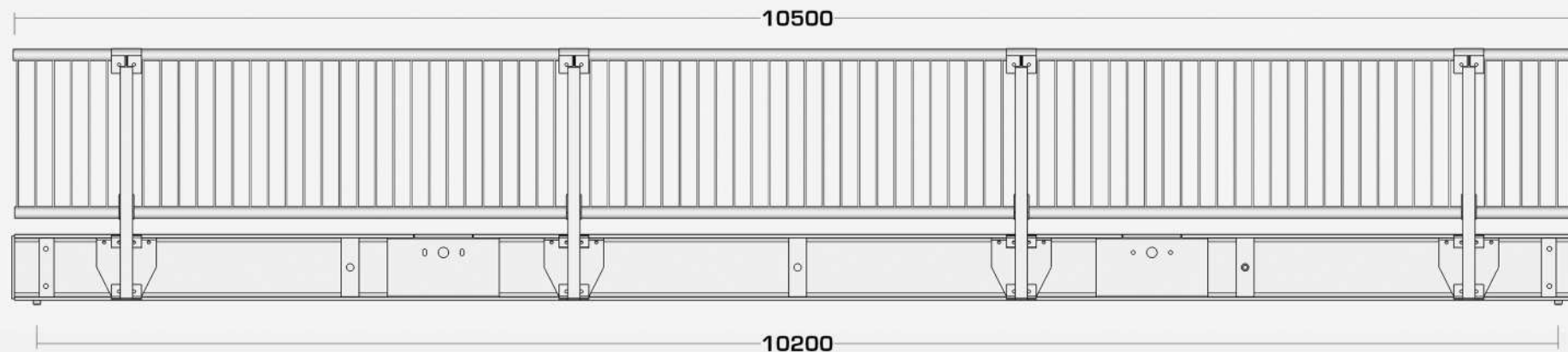

Seitenansicht

verfügbare Elementbreiten
1,50m und 2,10m
beliebig kombinierbar

nachweisbar: DIN-FB 101
DIN 1072
EuroCode

- 1,50m
- 2,10m
- 3,00m
- 3,60m
- 4,20m
- 4,50m
- 5,10m
- 5,70m
- 6,00m
- 6,30m
- 6,60m
- 7,20m
- etc.

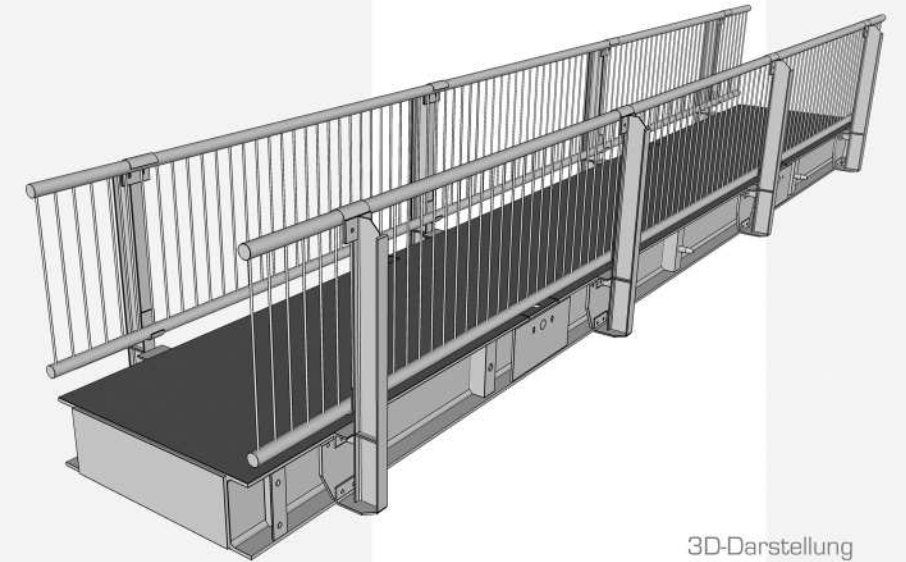

3D-Darstellung

JSK 450 - 10,50m x 3,00m

Janson Balkenbrücke Typ JSK 450

10,50m 13,50m 15,70m 21,00m

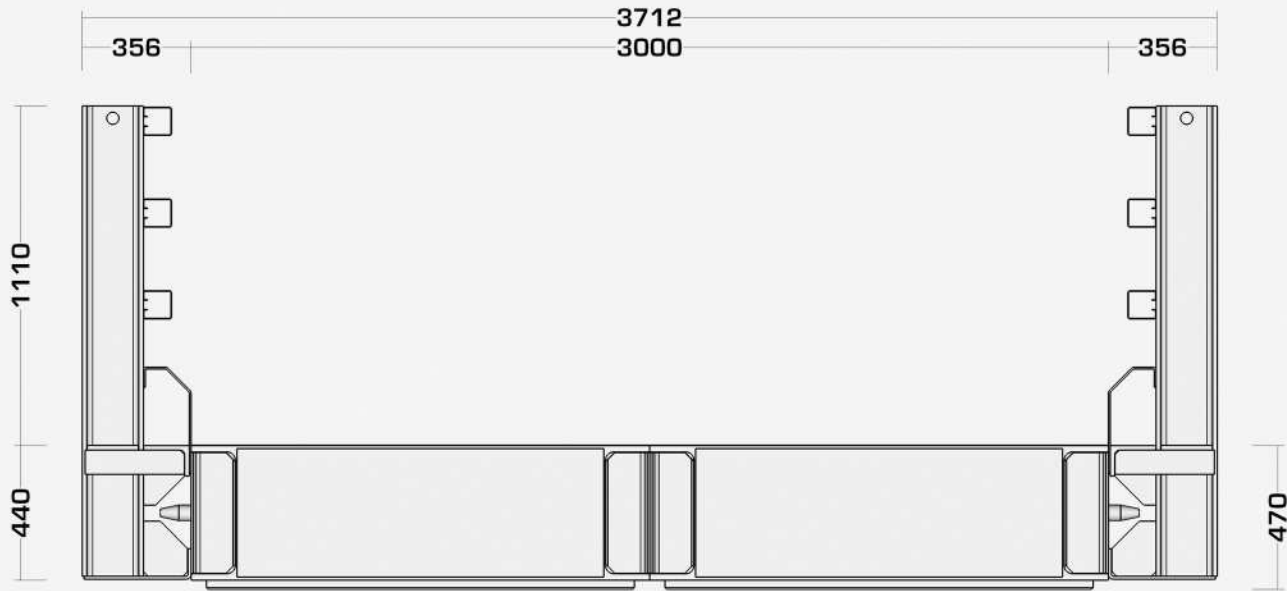

Vorderansicht

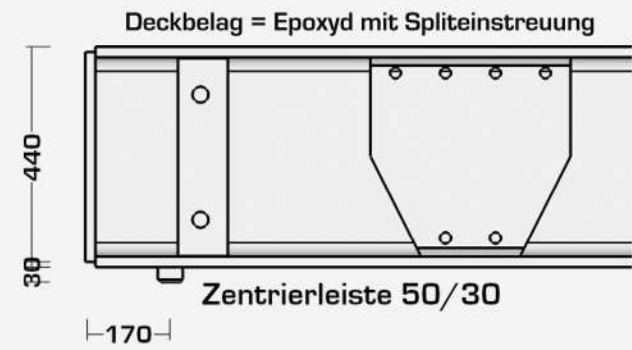

Detail: Auflager



Seitenansicht

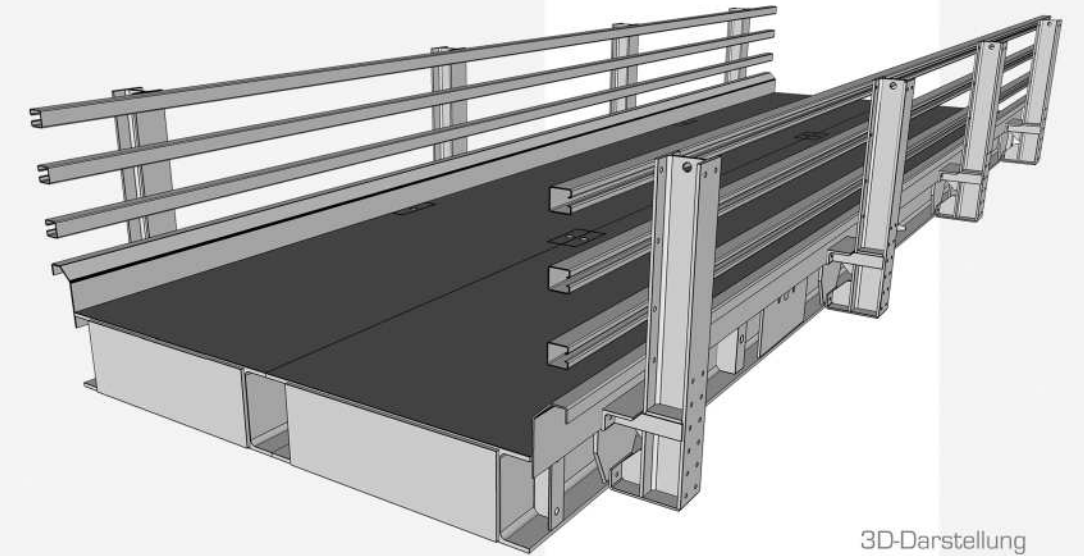

3D-Darstellung

verfügbare Elementbreiten
1,50m und 2,10m
beliebig kombinierbar

nachweisbar: DIN-FB 101
DIN 1072
EuroCode

- 1,50m
- 2,10m
- 3,00m**
- 3,60m
- 4,20m
- 4,50m
- 5,10m
- 5,70m
- 6,00m
- 6,30m
- 6,60m
- 7,20m
- etc.

JSK 450 - 10,50m x 3,60m

Janson Balkenbrücke Typ JSK 450

10,50m 13,50m 15,70m 21,00m

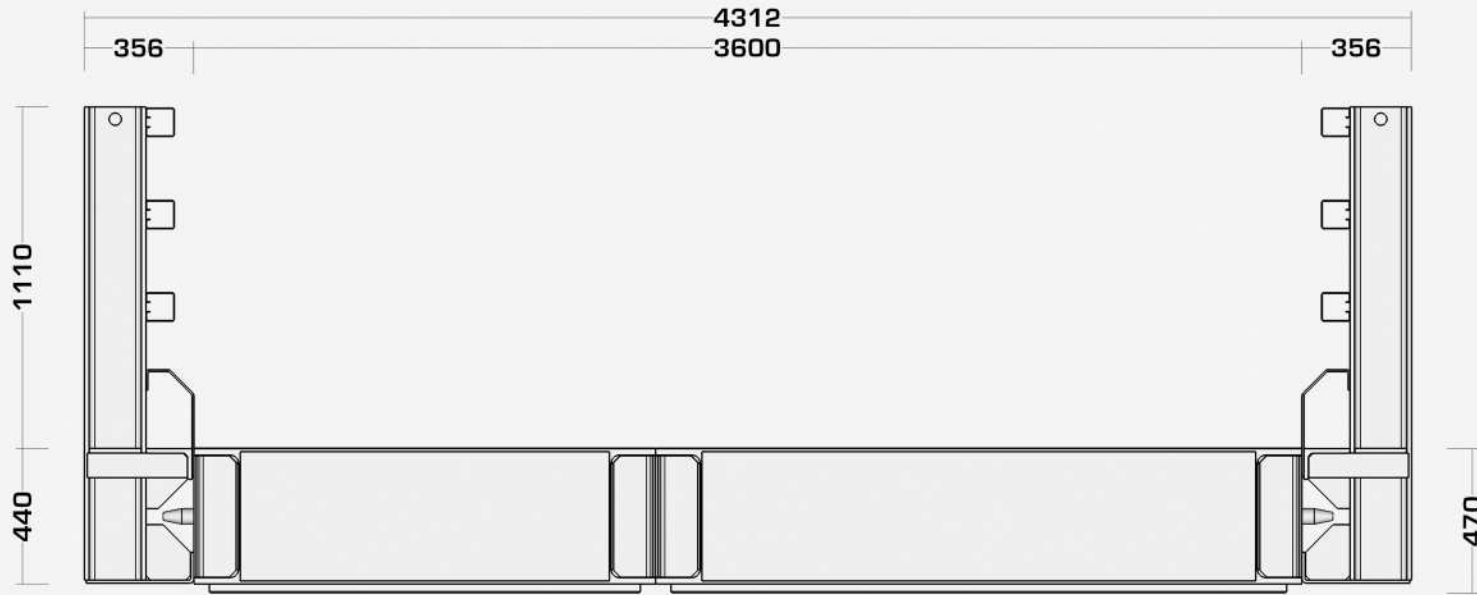

Vorderansicht

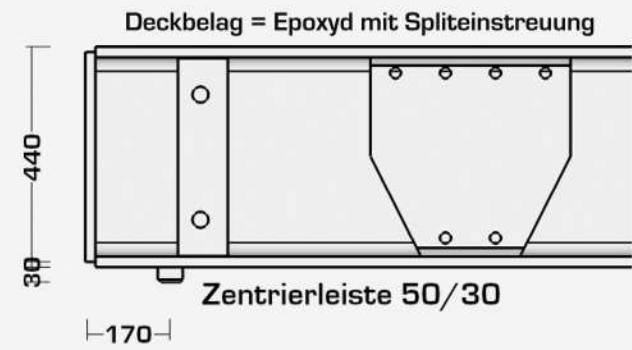

Detail: Auflager



Seitenansicht

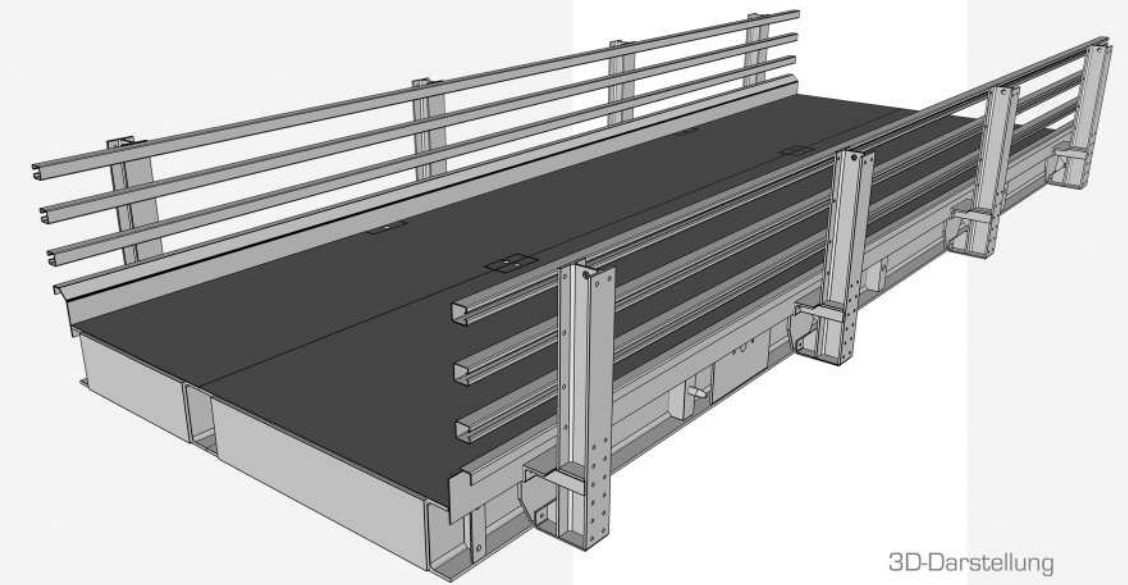

3D-Darstellung

verfügbare Elementbreiten
1,50m und 2,10m
beliebig kombinierbar

nachweisbar: DIN-FB 101
DIN 1072
EuroCode

- 1,50m
- 2,10m
- 3,00m
- 3,60m**
- 4,20m
- 4,50m
- 5,10m
- 5,70m
- 6,00m
- 6,30m
- 6,60m
- 7,20m
- etc.

JSK 450 - 10,50m x 4,20m

Janson Balkenbrücke Typ JSK 450

10,50m 13,50m 15,70m 21,00m

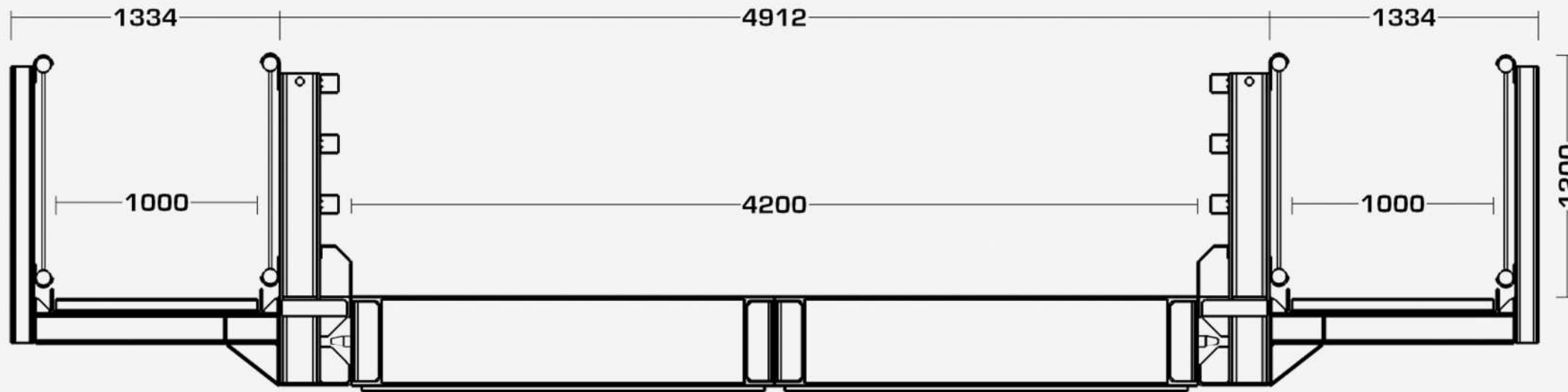

Vorderansicht

verfügbare Elementbreiten
1,50m und 2,10m
beliebig kombinierbar

verfügbare Gehwegbreite
1,00m, 1,50m und 2,00m
beidseitig anhängbar

nachweisbar: DIN-FB 101
DIN 1072
EuroCode

- 1,50m
- 2,10m
- 3,00m
- 3,60m
- 4,20m**
- 4,50m
- 5,10m
- 5,70m
- 6,00m
- 6,30m
- 6,60m
- 7,20m
- etc.

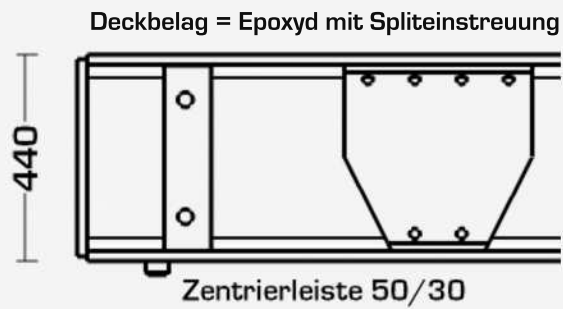

Detail: Auflager

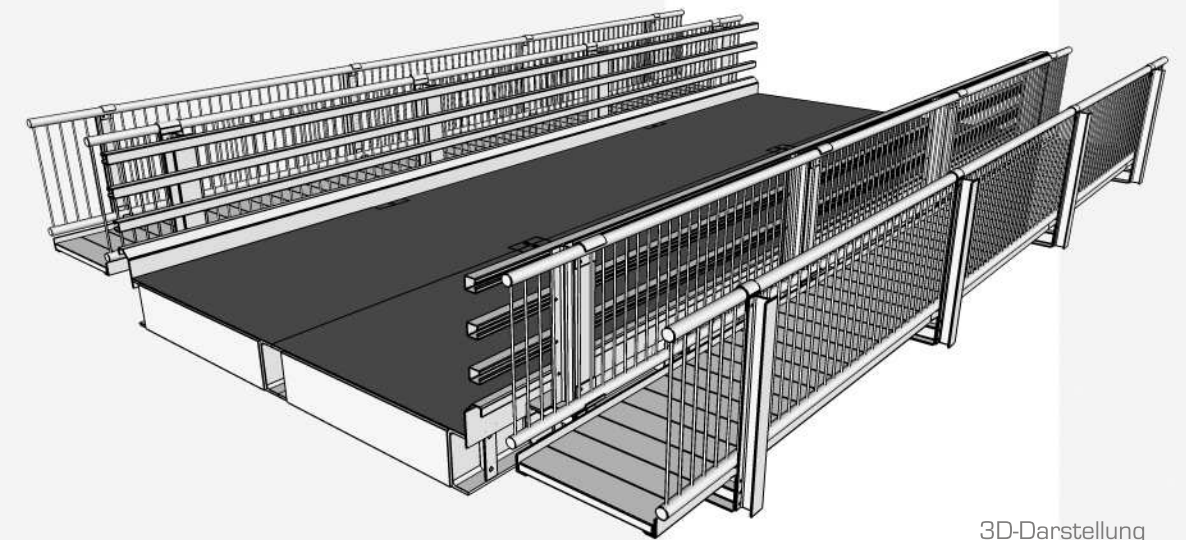

3D-Darstellung

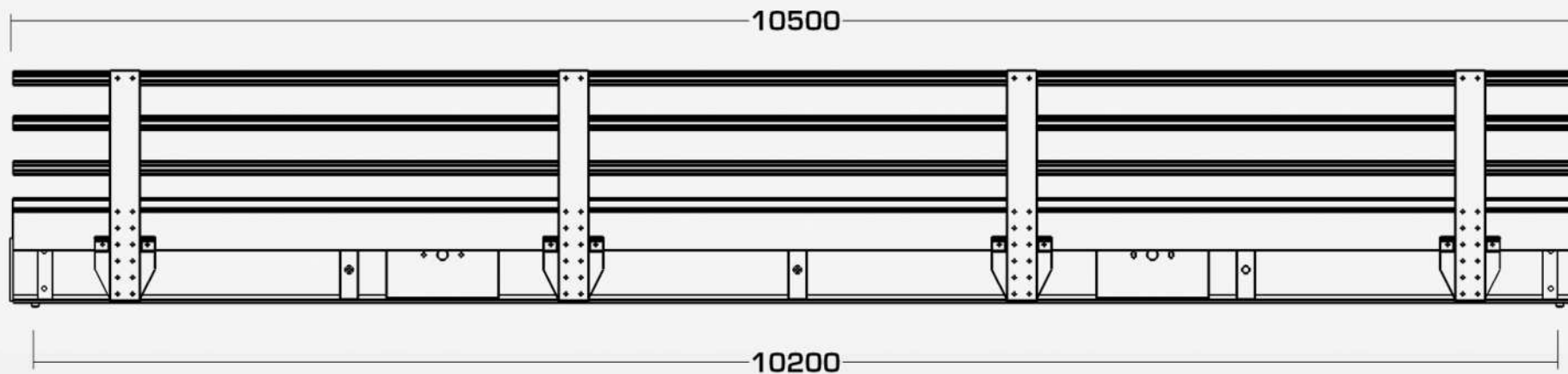

Seitenansicht

JSK 450 - 10,50m x 7,20m

Janson Balkenbrücke Typ JSK 450

10,50m 13,50m 15,70m 21,00m

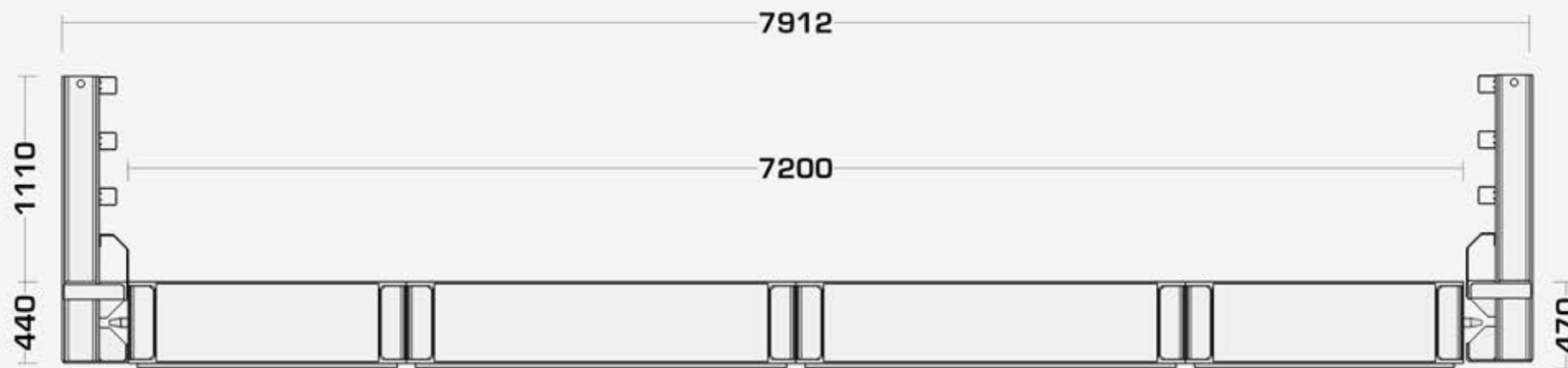

Vorderansicht

verfügbare Elementbreiten
1,50m und 2,10m
beliebig kombinierbar

verfügbare Gehwegbreite
1,00m, 1,50m und 2,00m
beidseitig anhängbar

nachweisbar: DIN-FB 101
DIN 1072
EuroCode

1,50m
2,10m
3,00m
3,60m
4,20m
4,50m
5,10m
5,70m
6,00m
6,30m
6,60m
7,20m
etc.

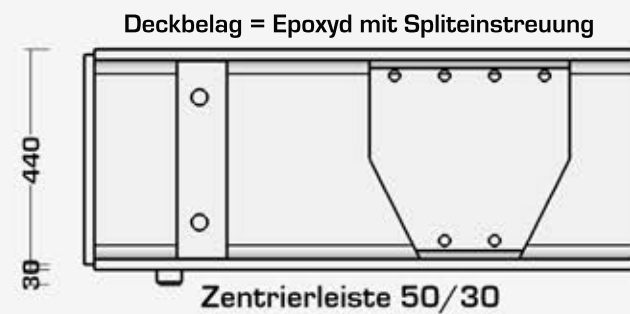

Detail: Auflager

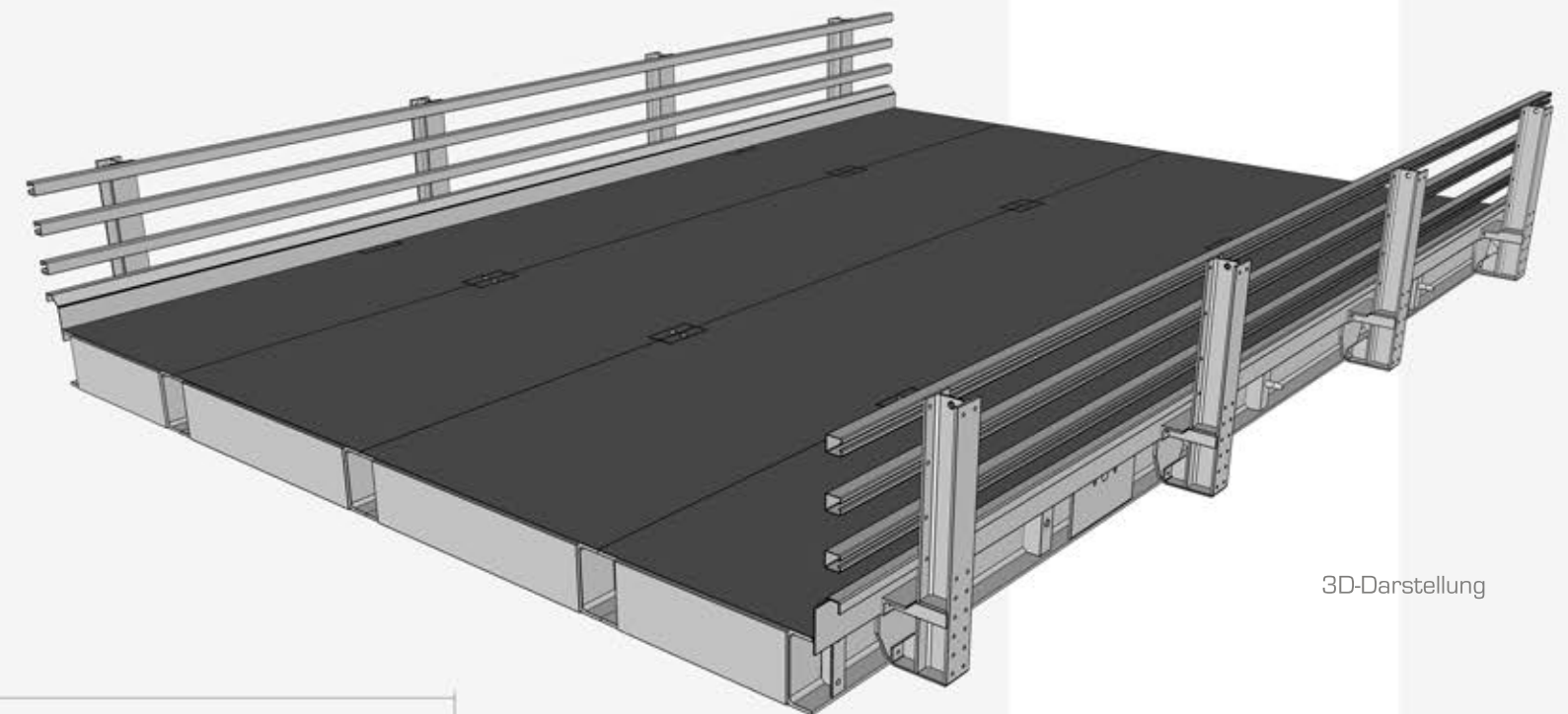

3D-Darstellung



Seitenansicht

JSK 450 - 10,50m x 7,20m GW - 1,50m

Janson Balkenbrücke Typ JSK 450

10,50m 13,50m 15,70m 21,00m

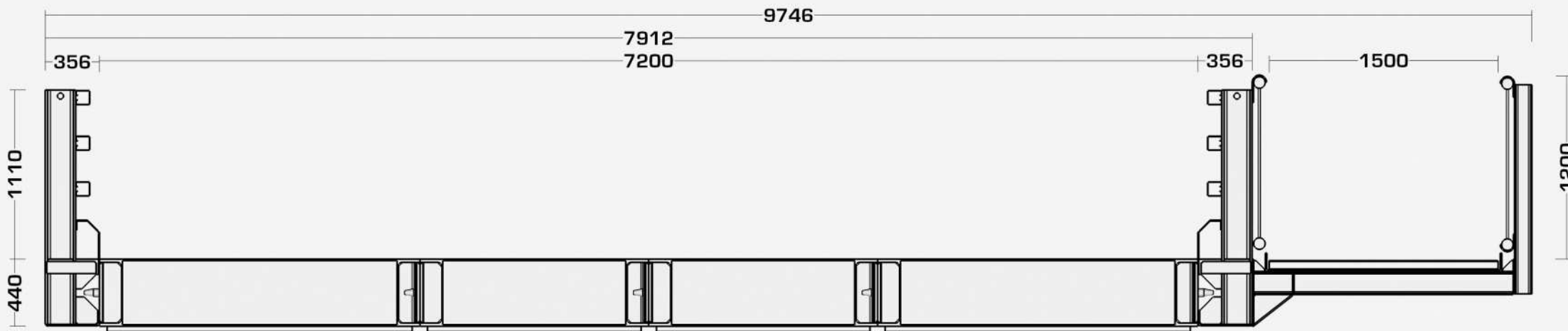

Vorderansicht

verfügbare Elementbreiten
1,50m und 2,10m
beliebig kombinierbar

verfügbare Gehwegbreite
1,00m, 1,50m und 2,00m
beidseitig anhängbar

nachweisbar: DIN-FB 101
DIN 1072
EuroCode

- 1,50m
- 2,10m
- 3,00m
- 3,60m
- 4,20m
- 4,50m
- 5,10m
- 5,70m
- 6,00m
- 6,30m
- 6,60m
- 7,20m**
- etc.

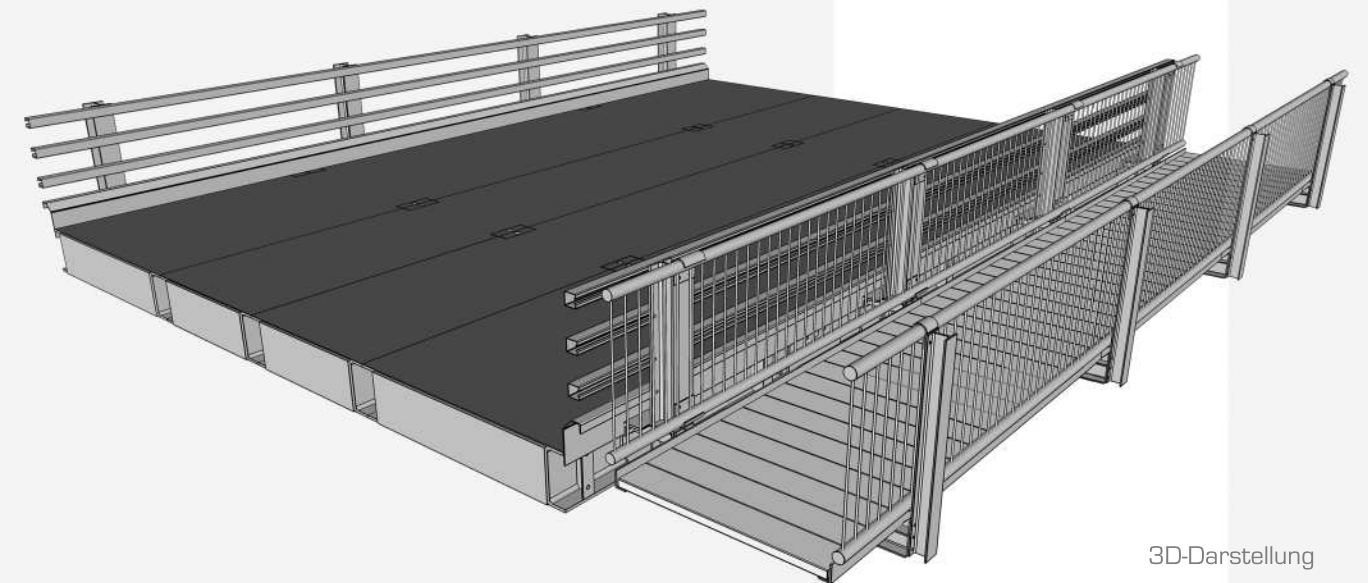

3D-Darstellung

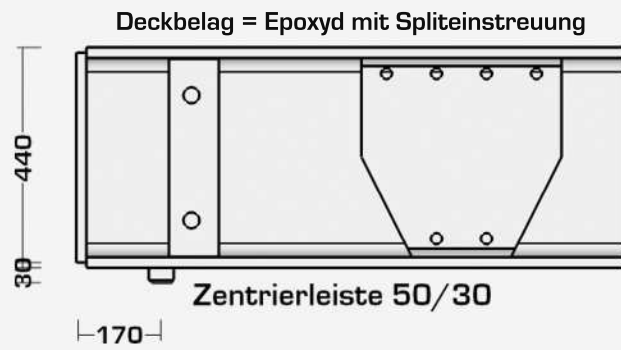

Detail: Auflager

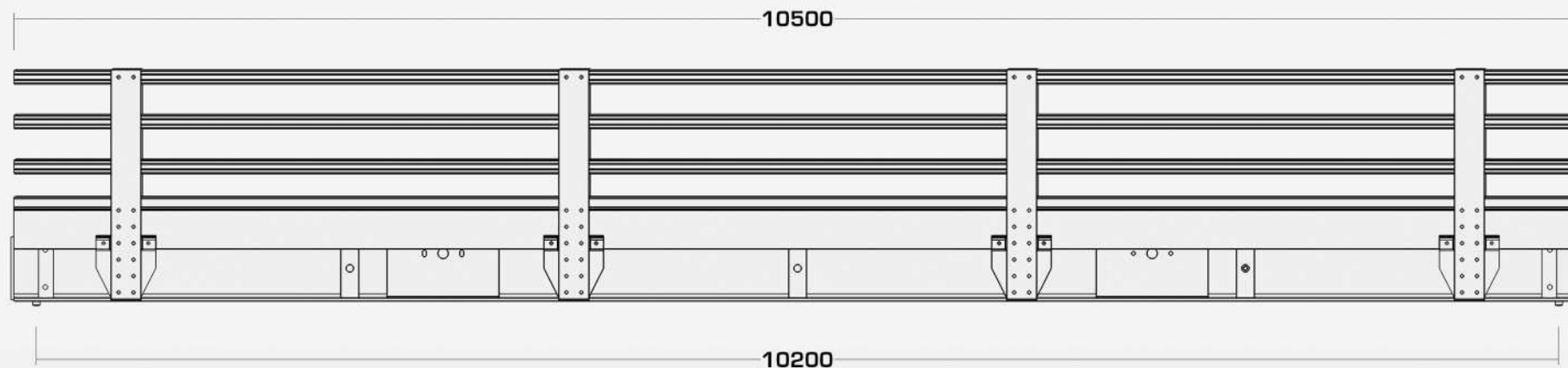

Seitenansicht